

WOODFOLD



Door Installation

DOOR SERIES: 240, 440, 540, 640 AND 740

BULLETIN INSTALL-STANDARD-120906



Read and understand these instructions before proceeding!

It saves frustration!



Beginning installation before checking things out is discouraged!

Measure Twice - Cut Once so to speak

1 PREPARATION

Preliminary Examination

Confirm the match of the packaged door to the intended opening. The example label to the right shows the location of the critical information.



Inspect the packaging. If the package was damaged when it arrived, contact the shipping carrier first, then notify Woodfold.

Lay out the contents on a flat surface near the opening where the door is to be installed.

The package(s) contents should include

- Door
- Track Section(s)
- Interlocking Jamb Molding (Aluminum extrusion a little less than the height of the door. See the top of Page 5 for description.)
- Hardware packet (Screws etc.)
- These instructions (Yes, yes, we know you had to find them if you're reading them, but we like to be complete.)
- A copy of the shipping label with all the information you need if you have to call Woodfold for any reason. Hold on to it for future reference.

Example Label

Your label will look similar but have your unique information

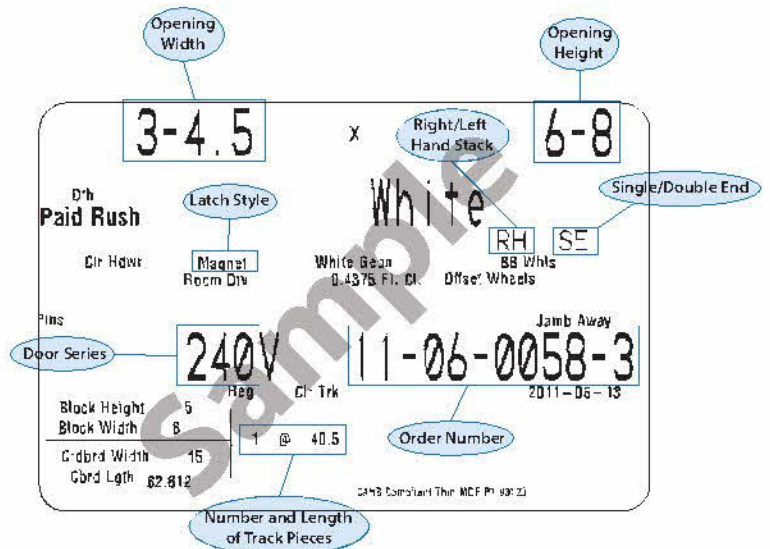

Caution! The factory greased the track for smooth operation! Hands and tools can spread the grease all over, so please be careful.

Woodfold Mfg., Inc
P.O. Box 346
Forest Grove, OR 97116

Voice [503] 357-7181
Fax: [503] 357-7185
www.woodfold.com

Door Stacking: DE, LH, RH or Pair

For the purpose of these instructions, doors come in three basic configurations: Double Ended (DE), Left Hand Stacked (LH) and Right Hand Stacked (RH). DE doors have Lead Posts at each end of the Panel set. LH and RH doors have a Lead Post on one end and a Mounting Panel on the other end. Left or Right handing is determined when the door is viewed from the front. Pairs are a set of LH and RH that meet in the middle.

Even and Odd Door Panels

The factory puts in enough door panels to fill the opening. That seems obvious but it means some doors have an even number of panels and others an odd number. The consequence is that the mounting panel on your door may point in the other direction than those shown in illustrations.

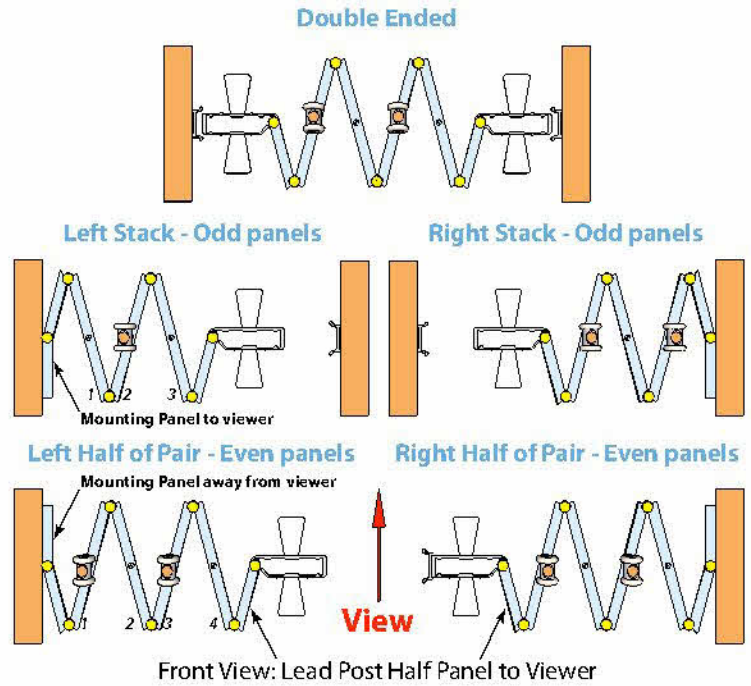

The next few steps are much easier if you have assistance

2 TRACK INSTALLATION (SEE ADDENDUM FOR BENDABLE I-BEAM TRACK)

There are different installation techniques for Standard (typically single section) Track and Pin (multi section) Track. Compare your track to the illustration and use the appropriate, following section.

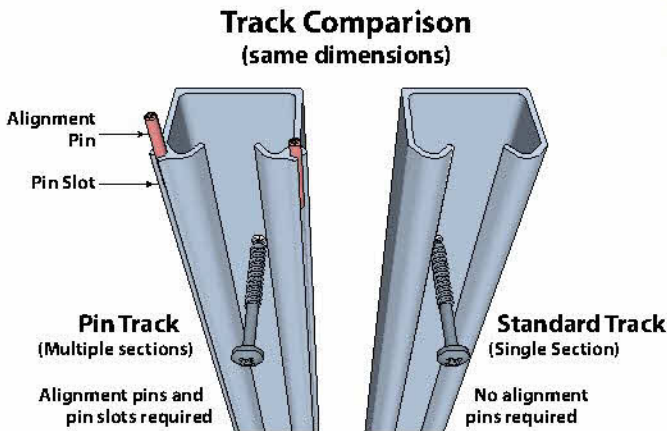

Need for alignment pins depends on the number of track sections. Short tracks with a single section will not have alignment pins or pin slots.

Note: Some Pairs may have two track sections that butt together without alignment pins. Not to worry! It's OK

Verify that the track length is correct.

Dry fit the track in the opening. The correct length will just fit. If needed, trim the track with a hacksaw. Try to keep the metal filings from mixing with grease inside the track.

If the track is too short by more than 1/2", contact Woodfold.



Important: Power Screw Drivers: Check the length of your #2 Phillips Bit. It needs to extend at least 1 1/4" past the chuck. Any shorter and the chuck may tear up the track or the screw won't seat. It falls into the frustrating category when you have to order a new track.



Caution! Firmly attach the track to the structural header!
Sheetrock and many decorative materials do not provide adequate support



Standard Track

Thread the track onto wheels; lineup the wheels properly in the track grooves. Be careful not to insert the wheels sideways. You won't like the result.

Confirm the proper orientation of the door. See the illustrations of Left or Right Stack doors or Double Ended doors at the top of Page 2. Position the track to ensure: a) it can be securely attached to the header and b) the Mounting Panel can be securely attached to the wall or doorjamb.



#8- 1 1/2" Pan Head

Track Screw

Stack the door to one end of the track (either side of the opening is OK) and attach the other end of the track to the header. Use #8 x 1 1/2" pan or truss head screws through the first 2 holes at the end of the track. Seat the head of the screw firmly against the track.

If the screws didn't go into a solid part of the header (soft stuff like sheetrock or acoustical tile doesn't count) at least 3/4", now would be a good time to go to the hardware store and get longer #8 Pan Head or Truss Head screws.

Transfer the door to the attached end of the track. Finish attaching the track with #8 x 1 1/2" pan or truss head screws.

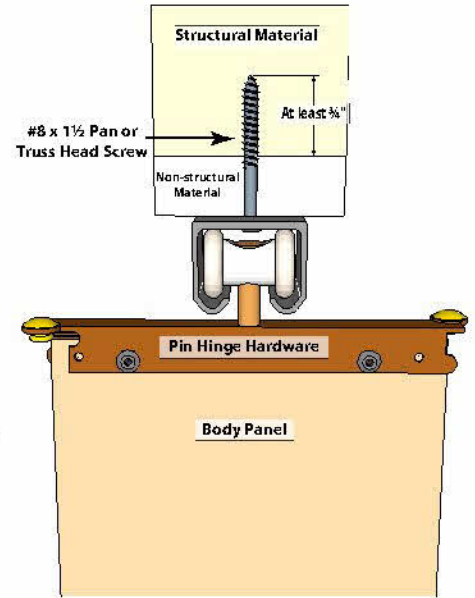

Pin Track (track is in two or more pieces)

Some Pairs are shipped with two track section without alignment pins. If the track sections do not have alignment pin slots go back to the **Standard Track** section and butt the track ends together in the middle.

Find the longest piece of track. If they are all the same size, just pick one, any one. Insert the alignment pins into the groove of the track at the end that will mate to the next section. The split in the pin **MUST BE AWAY** (perpendicular, see inset illustration below) from the slot in the track. Drive the spring pins completely into one track using a hammer.

Thread the track onto wheels; lineup the wheels properly in the track grooves. Be careful not to insert the wheels sideways. You won't like the result.

Stack the door to one end of the track section and attach the other end of the track to the header. Use #8 x 1 1/2" pan or truss head screws to attach the track to the header. Start at the jamb side where the door will stack and put in enough screws to accommodate the stacked door. Seat the head of the screws firmly against the track.

If the screws didn't go into a solid part of the header (soft stuff like sheetrock or acoustical tile doesn't count) at least 3/4", now would be a good time to go to the hardware store and get longer #8 pan or truss head screws.

Transfer the door to the attached end of the track. Finish attaching the track with #8 x 1 1/2" pan or truss head screws.

The doors may be heavy! Don't be a hero! Let the track do the lifting for you!

Repeat the process of inserting the alignment pins and attaching to the header for each remaining track section.

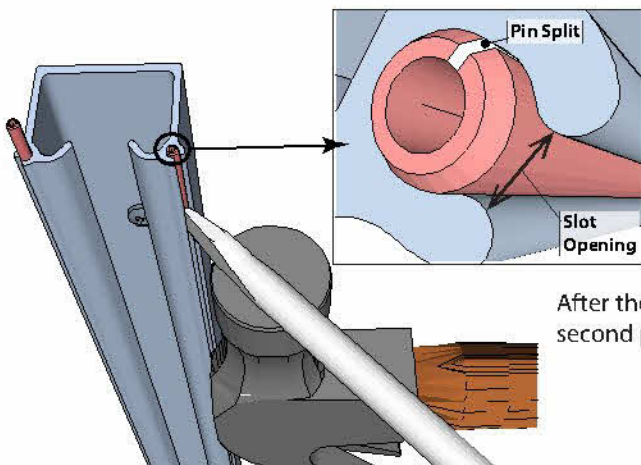

After the track has been secured, drive the alignment pins back halfway into the second piece of track with a hammer and the edge of a screwdriver.



Check it out! Move the door back and forth along the track looking for smooth operation. Most frequent problems include screw heads sticking out, wheels sideways or debris in the track.





This next section is most critical. Improperly installing the Mounting Panel results in the majority of trouble calls to Woodfold.
Repeat after me: **I will read this section. I will read this section.**

3. MOUNTING PANEL

If your door is a LH or RH stacked door or a pair (see the top of Page 2) you need to read this Section.

If yours is a DE door, forget the warning above and skip ahead to Section 4.

Push the door to the side that will be fastened permanently to the wall. Let the door form its own plumb (hang free) and carefully mark the wall with a pencil at the edge of the mounting panel near the top and bottom of the door.

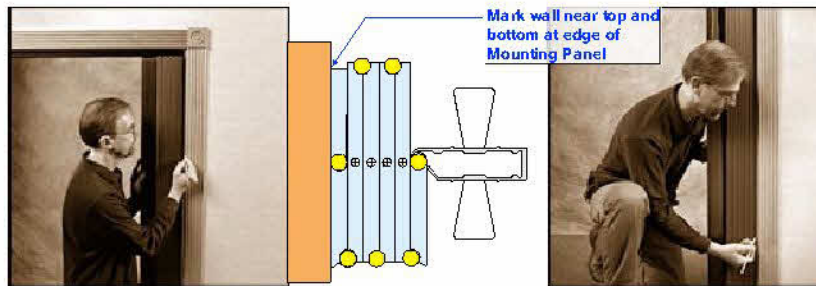

It is important! Make the marks while the door is in its stacked position or the door will not close properly.

OK! Here comes the critical step. You just marked the wall at the top and bottom of the mounting panel edge with the door stacked. Now, extend the door to have access to the Mounting Panel. Hold the Mounting Panel edge at the pencil marks at both top and bottom!

Caution! Take care when attaching the Mounting Panel to the wall. As you unfold the door to insert the screws, the position of the Mounting Panel may move away from your marks. Sometimes, the marks look "off" when the door is extended.

Trust your marks!

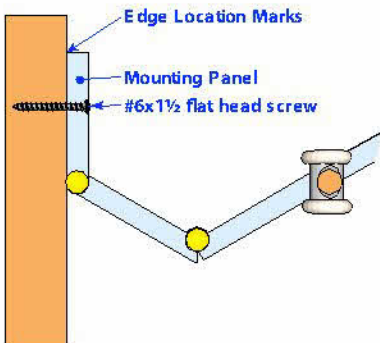

Insert #6 x 1 1/2" flat head screws about 8" up from the floor and 8" down from the track.



Check it out! Can you see the pencil marks? If not, the door has shifted. If there is a gap between the edge and your marks, the door has shifted the other way. Stack the door against the Mounting Panel; it should form a neat, tight stack. **DON'T** Force it. If it binds, you missed your marks!

When the door stacks properly, re-extend it and install 2 more screws between the first 2, about equal distances apart.



4 INTERLOCKING JAMB MOLDING

And now a short word about *Interlocking Jamb Moldings*

The Interlocking Jamb Molding is the extruded piece into which the door latches. If your door is a Pair, and slides from each end to meet in the middle, and your Interlocking Jamb Molding is already installed on a lead post of the door and you may disregard this section.

Configurations where the door closes to a wall or doorjamb will have a separate piece with a cross section like one of the profiles shown here.

Interlocking Jamb Molding Profiles

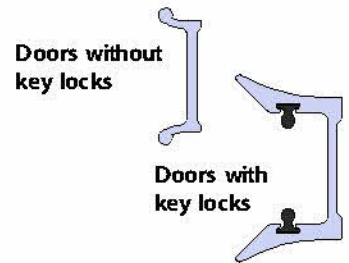

Hook style catch

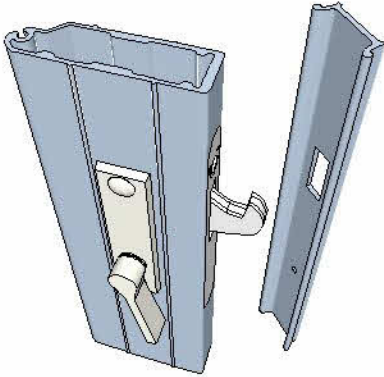

Dry fit the Interlocking Jamb Molding against the wall, directly under the track. It should fit snugly against the wall and the track at the top. If it needs to be trimmed, trim it at the **BOTTOM**. The arrow sticker on the back pointing up can easily determine top and bottom. The latch slot should correspond to the hook of the latch.

Trace the $\frac{3}{8}$ " x 1" slot in the Interlocking Jamb Molding onto the wall. Remove the Interlocking Jamb Molding and add $\frac{1}{2}$ " to the top of the tracing.

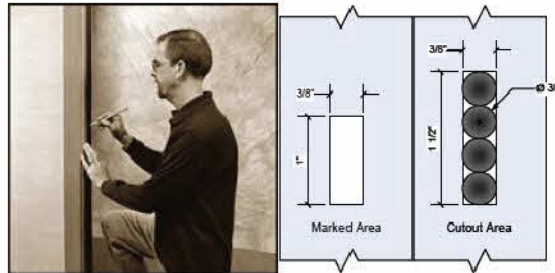

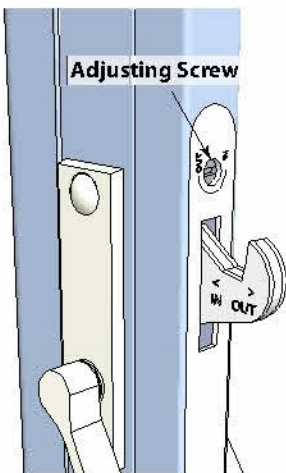

Drill a series of $\frac{1}{2}$ " deep holes within the marked area with a $\frac{3}{8}$ " bit. Clean out the waste with a sharp chisel.

Attach the interlocking jamb molding with #6 x $1\frac{1}{2}$ " flat head screws, through the pre-drilled holes and into the wall behind.



Shut the door, latch it and wiggle the handle a bit. The Latch should swing fully up with the Lead Post pulled snugly against the Interlocking Jamb Molding.

If the fit is too loose, or too tight, open the door and adjust the mechanism with a screwdriver.

Turn the Adjusting Screw clockwise  to loosen the fit, counterclockwise  to tighten.

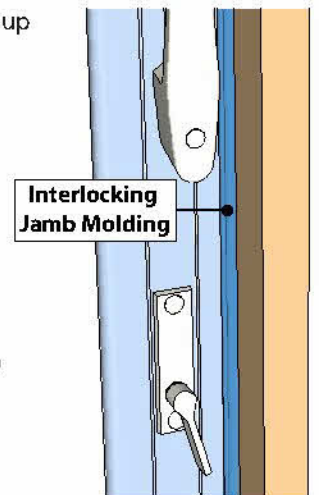

Magnetic Latch

Dry fit the Interlocking Jamb Molding against the wall, directly under the track. It should fit snugly against the wall and the track at the top. Each jamb molding is pre-cut to fit the opening, however, trim the molding with a hacksaw if needed.

Attach the Interlocking Jamb Molding to the wall with #6 x 1½" flat head screws.

Center the Strike Plate on the magnet with the adhesive side out. Remove the protective tape from the adhesive backing and push the door firmly shut.

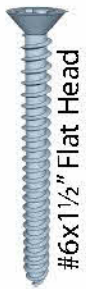

When you re-open the door, the strike plate should stay temporarily stuck in position. Drill through the center of each strike plate screw hole and Interlocking Jamb Molding using a ½" drill bit. Screw down the strike plate using 1½" #6 Flat head screws.

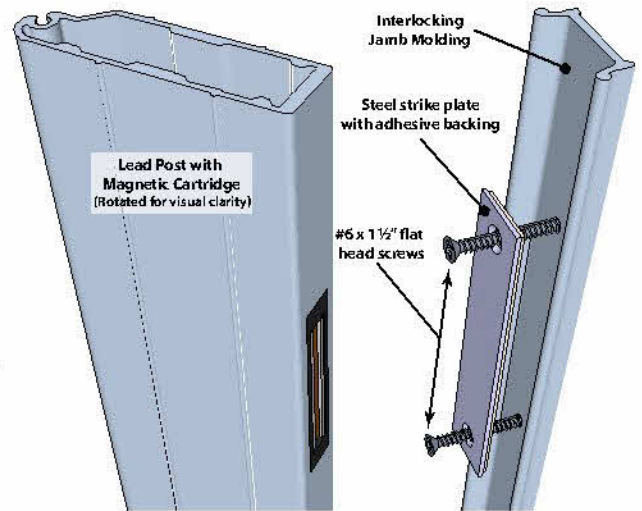

Check it out! Open and close the door a few times then step back and admire your work.

Installation is complete!

5 UPKEEP AND CARE SUGGESTIONS

OK! Now the door is installed, let's review it's love and care.

Operation/Maintenance

- For proper operation the track must be securely attached to the header, plumb and level. Vertical jambs must be perpendicular for proper operation. Use instructions for proper installation
- Do not rapidly pull or force any folding door across openings or around corners
- The hinge system may be stiff initially and will gradually ease after a period of time with regular use
- During normal use of your Woodfold door watch for instances of binding during movement. If there is binding, inspect the track for loose screws, dirt, debris and wheel alignment.
- Track may be periodically lubricated with a petroleum jelly type material. Do not use aerosol lubricants

Care/Cleaning

- Avoid exposure to excess or continued moisture
- As with all materials, exposure to light will cause fading
- Regular cleaning of the Vinyl/Acrylic/Aluminum/Veneer- use mild soapy water then dry with a soft cloth or chamois. Do NOT use household cleaners, abrasive towels or scouring pads.
- Wood veneer doors can be treated periodically using a furniture polish/cleaner
- Acrylic/Aluminum panel doors can be treated periodically with non-abrasive anti-static cleaner to reduce dust accumulation

Thank you for purchasing a Woodfold door.

